

HOME *life*
PODS
INCLUSIONS

D E S I G N · B U I L D · D E L I V E R



INCLUSIONS & UPGRADES

Experience the benefits of our Inclusions that are already at the highest quality.

From the Roof to the Footing construction and everything in between, the products HOMElife use will give you peace of mind that our Inclusions surpass the ordinary.

Choose your selections and make your home uniquely yours by using the Upgrade Selections.



D E S I G N · B U I L D · D E L I V E R

STANDARD

LAMINATE BENCHTOPS

32mm thickness
10x10 edge profile
Gloss or Matt

Polytec Standard colours



UPGRADE

20mm STONE BENCHTOPS

Quantum Quartz
20mm engineered stone

Standard and Delux Range



Sleek and Modern

STANDARD

KITCHEN, VANITY + LAUNDRY

Acrylic Splashback
Appearance and appeal of Glass Splashbacks
Stylish and grout-free



UPGRADE

TILED

National Tiles
Supply allowance \$60m2

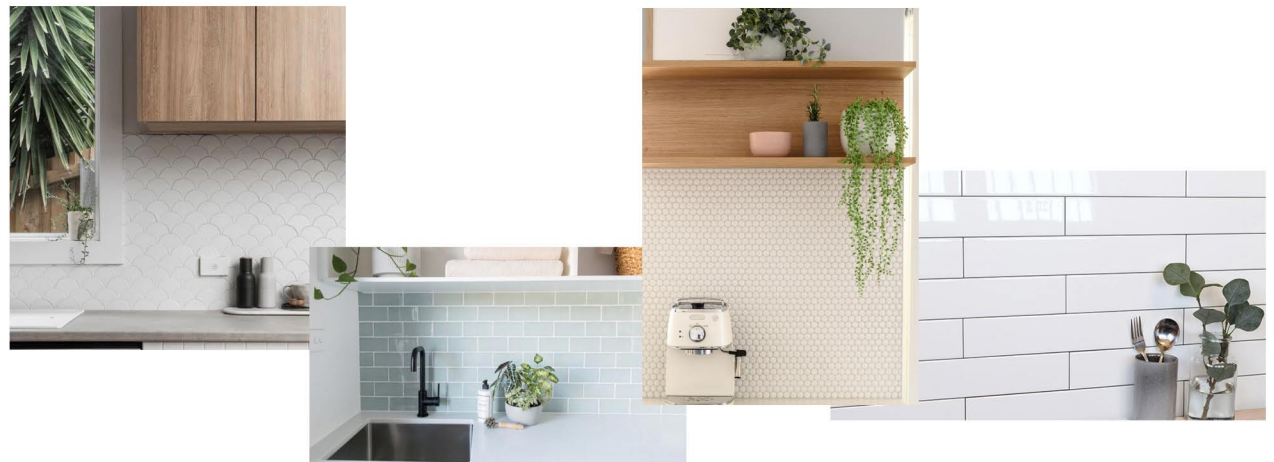

Sleek and Modern

STANDARD

TAPWARE AND SINK



UPGRADE

TAPWARE



Villa

Gaston*

Spin

Cadenza*

* pull out spray

1 1/2 AND DOUBLE SINKS



UNDERMOUNT SINKS FOR STONE BENCHTOPS



Every good chef knows it's about the tools of the trade

STANDARD

OVEN and COOKTOP



Bosch HBF133BS0A
60cm electric built in oven



Bosch PBH6B5B80A
60cm LPG/Natural gas cooktop

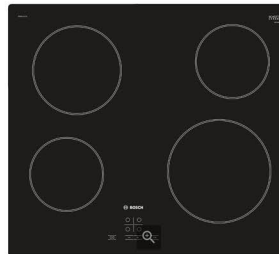

Bosch PKE611D17A
60cm electric cooktop

RANGEHOOD



Artusi 60cm Canopy Rangehood
ACH600X



Artusi 60cm under cupboard
rangehood AUM60

Exclusive cabinetry

STANDARD

LAMINATE CABINETY

polytec
laminates

HANDLES

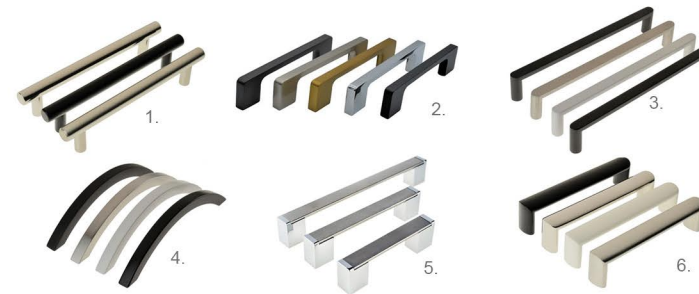

UPGRADE

CABINETY 2 PACK PAINTED



SOFT CLOSE MECHANISM



FINGER PULL OPENING



Durability

STANDARD

LAMINATE FLOORING Plank Tongue & Groove

National Tiles offers 'The Cabin' series is available in 5 stunning, European Oak influenced colours with a matt finish as well as a bevelled edge for a more authentic floorboard look.



UPGRADE

HYBRID Plank Tongue & Groove

Supplier National Tiles is combining the look and feel of real timber with the durability and versatility of vinyl and laminate flooring, the Kimberley Hybrid series offers a beautiful natural looking finish that is water resistant.



CARPET Bedrooms



Supply allowance \$40m2

Embrace the luxury

STANDARD

SHOWER shower size as per plans



Semi frameless glass
Shower door magnetic seal
6mm framed glass



Premium sanitary grade acrylic base



White acrylic shower walls
Low maintenance and easy to clean
Reduces mould growth



Glass shower shelf

UPGRADE

Tiled Shower

Tiled Shower Base

+

Tiled Shower Walls 2000mm

+

Tiled Shower Niche/Shelf

STANDARD

BATHROOM FLOOR & 150mm WALL SKIRTING

Supplier National Tiles
Supply allowance \$50m²



UPGRADE

1200mm HIGH WALLS

Supplier National Tiles
Supply allowance \$50m²



Flawless finishes

STANDARD

SHOWER



SHOWER MIXER



VANITY MIXER



ACCESSORIES

600mm double towel rail



Hand towel holder



Shower glass shelf

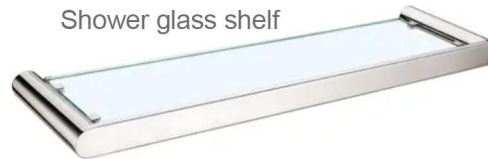

Toilet paper holder



Robe hook



Toilet brush holder



Flawless finishes

STANDARD

SHOWER



SHOWER MIXER



VANITY MIXER



ACCESSORIES

600mm double towel rail

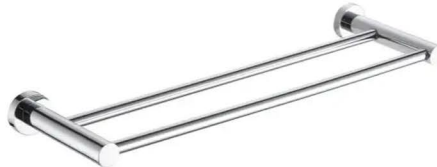

Shower glass shelf



Towel holder



Toilet paper holder



Robe hook



Toilet brush holder



Flawless finishes

STANDARD

SHOWER



SHOWER MIXER



VANITY MIXER



ACCESSORIES

600mm double towel rail



Shower glass shelf



Towel holder



Toilet paper holder



Robe hook



Toilet brush holder



Seemlessly awe-inspiring

STANDARD

BASINS

Ceramic top with integrated basin
Finger pull handles
Soft closing doors and drawers



600mm



750mm
Size as per plan



900mm

UPGRADE

BENCH MOUNT



FINE LINES
OMEGA Bench Mount Basin Gloss
White

BENCH MOUNT



FINE LINES
CIELO Bench Mount Basin Matte White

SEMI RECESSED



KATANA
Inset Basin Gloss White

SEMI RECESSED



DROMANA
Inset Basin Gloss White

UNDERMOUNT



MALABAR
Undermount Basin Gloss White

STANDARD

BATHROOM FIT OUT

Free flowing spaces



Frankie Rimless



Exhaust fan



Mirror 5mm pencil edge

UPGRADE



Bathroom Heat Lamps



Vanity Mirror Cabinet

STANDARD

BATHS Decina premium grade acrylic built in



1653 x 730 x 435
Novara

UPGRADE



1645 x 8115 x 510
Modena



1790 x 755 x 480
Turin



1790 x 820 x 480
San Diego



Cortez
1670 x 765 x 450
6 Jet Spa Bath

BATH SCREENS



Applicable if bath has a shower
Pivot panel bath shower screen.
EZI clean glass coating keeps the glass spotless
6mm toughened glass.

Indulge your Imagination

STANDARD

ROBE internal fit out

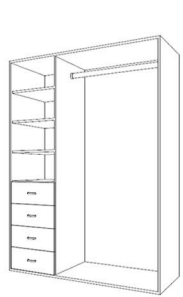

2 doors
1200 - 2400mm

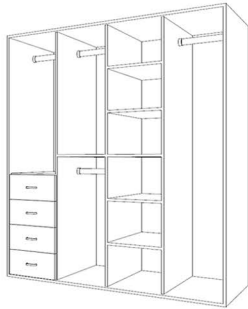

2 doors
1500 - 2400mm



2 doors
1800 - 2100mm



2 doors
1800 - 2400mm

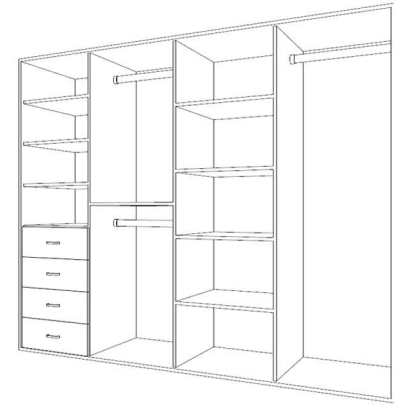

3 doors
2400 - 2700mm

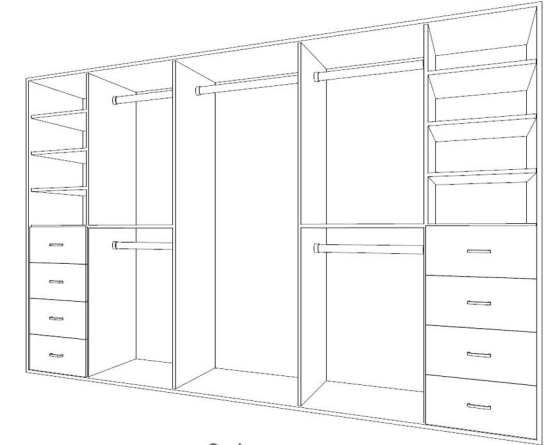

3 doors
2700 - 3600mm

STANDARD

ROBE DOORS vinyl

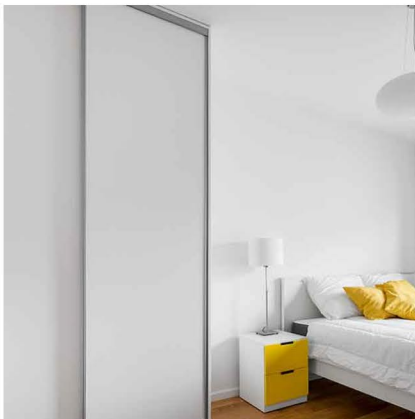

White vinyl doors with
chrome frame

UPGRADE



Mirror sliding doors with
chrome frame

Everyday laundry tasks made smarter

STANDARD

LAUNDRY



Laundry tub and cabinet
Size as per plan



Chrome mixer tap
Pull out spray



Exhaust fan

UPGRADE



Laminate benchtop with cupboard
Drop in tub



Robinhood Ironing Centre
One piece ironing board that folds away.
Built in light, ironing power point with timer.
Height adjustable and can be rotated.
Cotton coated rayon ironing board cover.
Storage shelves.
Sturdy galvanised cabinet.
2m power cord for connection.
Recessed in to the wall.

Australian hardwood & composites

STANDARD

MERBAU DECKING HARDWOOD

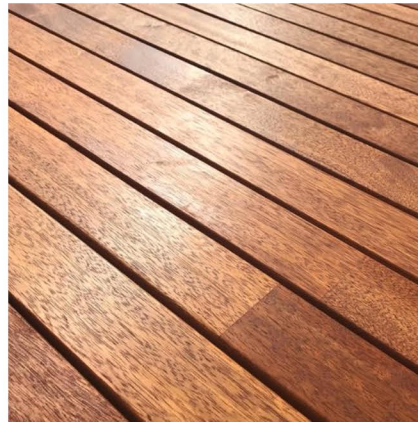

304 stainless steel decking screws
Countersunk



Natural oil

UPGRADE

EKODECK COMPOSITE DECKING

Engineered to look and feel like natural timber decking, Ekodeck is more durable and long-lasting and requires much less maintenance than timber and is environmentally friendly.



STANDARD

INSULATED PANEL PATIO

Insulated panel with outstanding thermal performance
Design flexibility
Wide range of colours
Large spans achievable

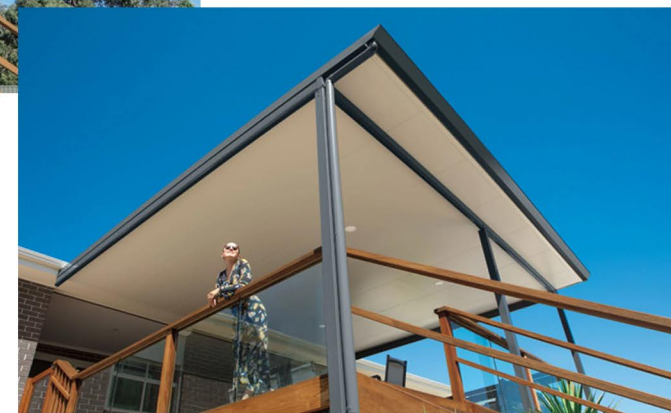
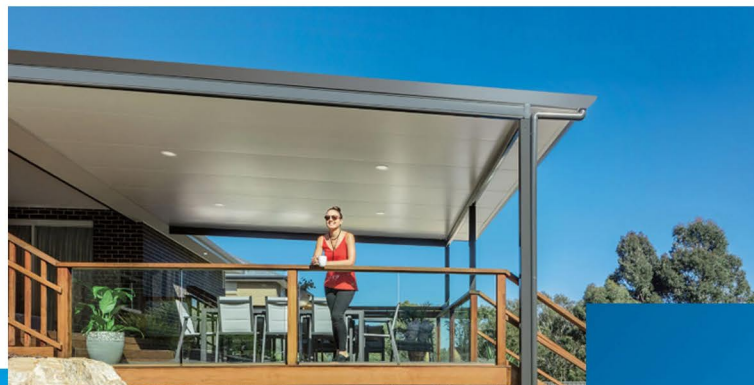

Luxury fixtures. Finer details that count.

STANDARD

SWITCHES & POWERPOINTS *Clipsal Iconic Series*

Standard colour:

VIVID WHITE

Featuring translucent edges & Vivid White skins



UPGRADE

Clipsal Iconic Colour options

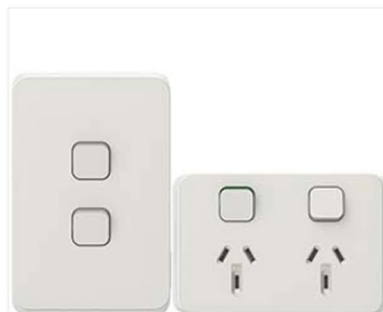

Warm Grey

Featuring translucent edges for a design that blends in with any wall colour.

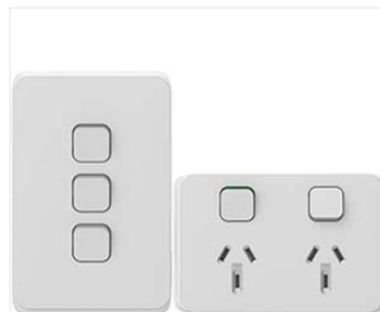

Cool Grey

Featuring translucent edges allowing the skin to infuse with the wall colour.

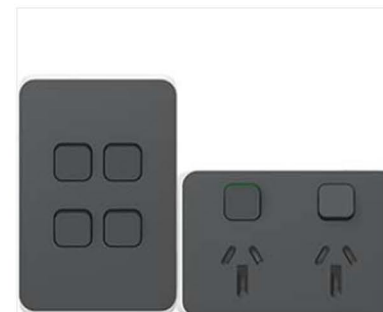

Anthracite

Featuring translucent edges allowing the skins to pick-up background colours.

Functionality

STANDARD

INTERIOR LED DOWNLIGHTS



10W LED 90mm downlight
910 lumen

Switchable Kelvin Ratings -
Warm white, Cool white or Day light



48" ceiling fan
White timber blades
3 speed settings
All-Seasons technology

UPGRADE

EXTERIOR LIGHTING



Functionality

STANDARD

AIR CONDITIONING Carrier



Carrier split system
Cool & Heat inverter
Super quiet operation
Brushless DC inverter technology
Self cleaning

Sizes as per plans

2.6kw

3.5kw

5.0kw

7.0kw

UPGRADE

AIR CONDITIONING Daikin



Daikin split system
Cool & Heat inverter
Super quiet operation
Daikins A-PAM DC inverter technology
Tempo's self clean technology

Sizes as per plans

2.6kw

3.5kw

5.0kw

7.0kw

Providing all the hot water you need

STANDARD

HOT WATER GAS

LPG continuous
flow hot water system

Compact in design

Endless hot water flow



SMOKE ALARMS



240v with 9v battery back up
Approved to AS3786:2014
Photoelectric technology design

INTERIOR SWITCHBOARD



Clipsal Resi MAX interior switchboard
Flush interior mount
1 - 12 modules per row
White colour

UPGRADE

HOT WATER ELECTRIC



Rinnai Hotflo Electric
Storage

Sizes as per plan:

Australian made

315L

Thermostatically
controlled

250L

160L

Pressure relief valve

125L

80L

Flexible style meets durability

STANDARD

A & L WINDOWS | DOORS

Aluminium framed glass sliding doors and windows

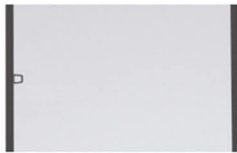

Fly Screens

Available in a range of mesh options.







Colour options

Choose a colour to see it in application.

-  **Precious Silver**
VIC, QLD & NSW only
-  **Black**
-  **Monument**
-  **Champagne**
QLD & Nth NSW only
-  **Dune**
VIC only
-  **Surfmist**
-  **White**
-  **Merino**
-  **Woodland Grey**

Glass options

Choose a finish to see it in application.

-  **Clear**
-  **Satinlite**
-  **Mettalux / Acid Etched**
-  **Translucent**
-  **Grey Tint**
-  **Ultra Grey**
QLD & NSW only

UPGRADE

DOUBLE GLAZING

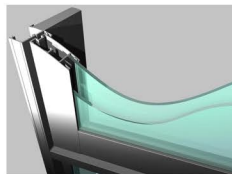

DIAMOND GRILL SCREENS



Barrier Screens with Diamond Grille

Available in QLD & NSW only. Available in a range of mesh options. Black grille as standard, colour matched grille available.

BARRIER SCREENS



Secureview Barrier Screens

Available in QLD & NSW only. Added protection without the need for an obstructive grille.

STANDARD

DOORS

INTERNAL DOOR
HOLLOW CORE
FLUSH PANEL



EXTERNAL ENTRANCE
SOLID CORE
FLUSH PANEL



CAVITY SLIDING DOORS
HOLLOW CORE
FLUSH PANEL



Corinthian flush panel doors are pre-primed ready for painting,

Flush doors are suited to both contemporary and traditional style homes.

UPGRADE

ENTRY DOORS OPTIONS

Corinthian Decorative Entrance
Painted or stained timber



ELEMENTS



BLONDE OAK



LUMINA WHITE OAK



INFUSION BLADE



INFUSION METAL



SUNBURST



INFINITY



MADISON



SLIMLITE



SEABOARD



INTERBLIND



BACKDOOR



CLASSIC



URBAN



SOLIDCARVE



BAL 29 RURAL



BAL 29 INFUSION METAL



PRIMED BAL 40

Enter with Style

STANDARD

ENTRY DOOR HARDWARE Standard

ENTRANCE
Front door



Lock or unlock with turn button inside or key from outside

PRIVACY
Bathrooms & Bedrooms



Turn button lock and emergency access from outside to suit bedrooms and bathroom

PASSAGE
Hallways & Cupboards



Non locking

Gainsborough G4 series
Ambassador lever
Satin Chrome

UPGRADE

DOOR HARDWARE Options



Lockwood Spire Velocity
Satin Chrome Pearl



Gainsborough G4 Series Lianna
Satin Chrome



Lemaar Calida
Chrome plated



Lane Victoria
Satin Chrome



Gainsborough Manning
Stainless Steel

Enter with Style

STANDARD

DOOR HARDWARE



Gainsborough
Privacy Lock



Cavity slider finger pull



Satin or Chrome to match door hardware.

Quality metallic finish, magnetic doors stops hold your door open and stop your door from damaging walls or slamming shut.

UPGRADE

CAVITY SLIDER OPENING Soft close & touch open

NEW RELEASE



SOFT CLOSE & TOUCH OPEN

The Evolution Complete is the perfect flush cavity sliding door system. Hume Doors have designed the Evolution Complete to incorporate our one touch release and soft closing technology, allowing for the most effortless operation of any sliding door system. The one touch release is magnetised and will hold your door firmly inside the cavity. With one easy touch the spring-loaded system will release the door, sliding with ease across the opening while the soft closer will gently slow and close the door.

IMPROVED PERFORMANCE
EVOLUTION COMPLETE



EVOLUTION TOUCH
ONE TOUCH CAVITY RELEASE SYSTEM

- ✓ HOLDS DOOR FLUSH IN CAVITY
- ✓ ONE TOUCH TO RELEASE DOOR
- ✓ EFFORTLESS OPERATION
- ✓ CAN BE FACTORY FITTED

STANDARD

ROLLER BLINDS



Blockout

- ✓ Great for blocking out light
- ✓ Provides ultimate privacy
- ✓ Perfect for bedrooms
- ✓ Great insulation from outdoor temperatures



Light Filtering

- ✓ Diffuses and softens light
- ✓ Provides daytime privacy without darkening the room (varies with colour and material choice)



Sunscreen

- ✓ Allows for daytime privacy
- ✓ Blocks 95% of UV rays
- ✓ Ideal for reducing glare & heat while maintaining a view

UPGRADE

DOUBLE ROLLER + CURTAINS



Double Roller Blinds



Sheer Curtains

- ✓ Softens light
- ✓ Ideal for adding texture to a room
- ✓ Layer with blockout fabrics for night time privacy
- ✓ Australian made



Blockout Curtains

- ✓ Ideal for blocking out light
- ✓ Provides ultimate privacy
- ✓ First choice for bedrooms
- ✓ Offers great insulation
- ✓ Australian made

Fresh, light filled spaces

STANDARD

SKILLION with RAKED CEILING



Raked & Pitched ceilings typically follow the shape of the trusses and beams in the room, rather than having a flat ceiling.

Benefits:

- * Makes the room feel bigger
- * Enjoy more air flow
- * More light to bounce off walls
- * Architectural feature with clean lines

GABLE with PITCHED CEILING



Fresh, light filled spaces

STANDARD

PLASTERBOARD interior walls & ceiling

10mm plasterboard with set & sanded joins
10mm Aquachek or Villaboard to wet areas



PAINT



3 coat Dulux system
Interior 1 colour
Dulux White on White

UPGRADE

SQUARE SET CORNICE



FEATURE PANEL



PAINTED FEATURE WALL
TO BEDROOM + LIVING

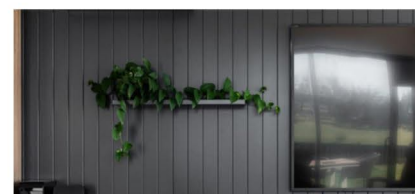

WALL & CEILING
FINISH

Clean lines and modern look

STANDARD

JAMES HARDIE PrimeLine Weatherboard

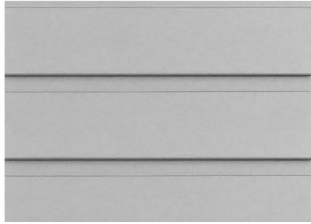
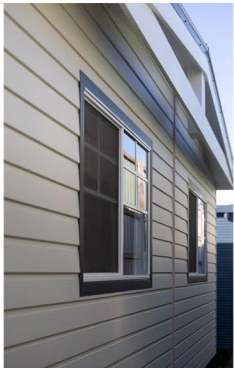

Primeline Weatherboard



PICTURE FRAME Detail



UPGRADE

JAMES HARDIE

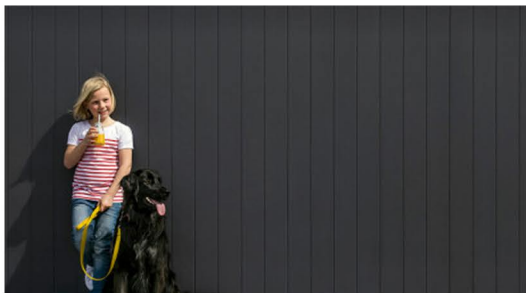

Axon Cladding



HardiePlank Weatherboard



Stria Cladding



HardieFlex Sheet

UPGRADE

WEATHERTEX paintable

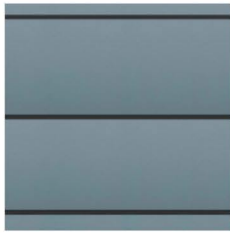

PRIMELOK SMOOTH 200mm



PRIMELOK FEDERATION SMOOTH
170mm



PRIMELOK SHADOWOOD SMOOTH
170mm



PRIMELOK WOODSMAN 200mm



PRIMELOK FEDERATION RUFF
SAWN 170mm



WEATHERGROOVE SMOOTH 75mm



WEATHERGROOVE WOODSMAN
75mm



WEATHERGROOVE SMOOTH 150mm



WEATHERGROOVE SMOOTH 300mm



SELFLOK MILLWOOD RUFF SAWN
300mm



SELFLOK ECOGROOVE WOODSMAN
150mm



SELFLOK ECOGROOVE WOODSMAN
300mm



SELFLOK ECOGROOVE NATURAL
150mm



SELFLOK ECOGROOVE NATURAL
300mm



SELFLOK VGROOVE NATURAL
150mm



WEATHERGROOVE NATURAL 75mm



WEATHERGROOVE NATURAL 150mm



WEATHERGROOVE NATURAL
300mm



Insulation acts as a barrier to heat flow and is essential for keeping your building warm in winter and cool in summer.

CLIMATE CONTROLLED

INSULATION

Cool in Summer, Warm in Winter

STANDARD

WALL INSULATION

- Reduced heat transfer
- Improved comfort
- Saves energy costs
- Low allergen
- Non combustable

90mm wall batts R2.0



STANDARD

CEILING INSULATION

- High thermal performance - year round
- Sound absorbing
- Non combustable
- Saves energy
- Odourless

140mm ceiling batts R3.5
190mm ceiling batts R4.0

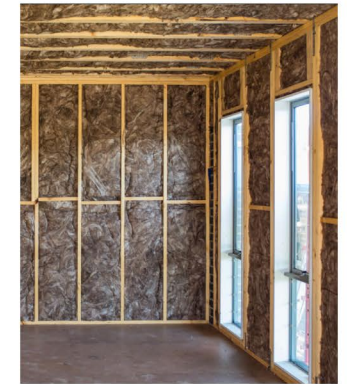

STANDARD

WALL WRAP

The reflective foil provides extra R value and protects against wind, dust and moisture entry.

By reducing air infiltration makes the building more comfortable and helps insulation work more efficiently.



STANDARD

ROOF ANTICON



- Thermal insulation
- Acoustic insulation
- Non combustable
- Condensation control
- Environmentally sound

80mm Anticon R1.5

STANDARD

CONTEMPORARY RANGE



UPGRADE

MATT RANGE creating a softer, more subtle look

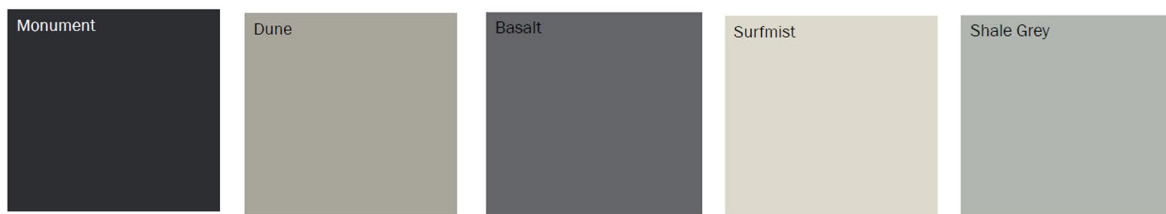

STANDARD

ROOF PROFILE

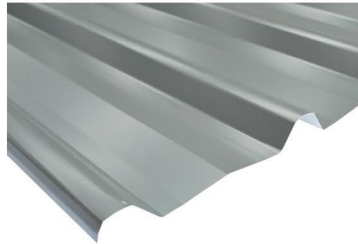

Monoclad 0.42mm BMT
Colorbond standard range

FASCIA / BARGE

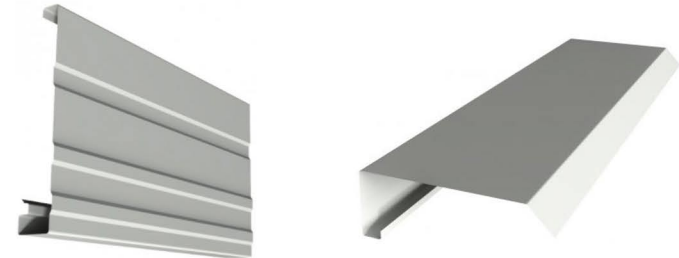

Flashings and Barge
Colorbond standard range

GUTTER



Square Gutter
Colorbond standard range

DOWNPIPES



90mm PVC downpipes
Painted as per plans

STANDARD

MAXIMUM 600mm fall across site/pad prepared by the Client

CONCRETE PIER FOOTING

Piering involves your builder excavating a number of holes throughout the site, which will later be filled with concrete to strengthen the foundation of your new home.

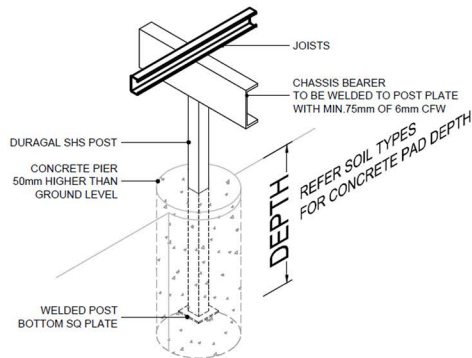

FOOTING DETAIL
SUB-FLOOR POSTS



SUREFOOT FOOTINGS

Concrete Free

Surefoot Footings is the concrete free alternative to traditional concrete footings.

Surefoot is high strength, hybrid 'all-in-one' steel footings which are specifically designed to increase its efficiency when resisting gravity, uplift, shear and moment loads. Ideally used with limited site access.

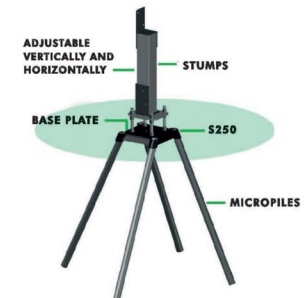

Completely Level

STANDARD

ADJUSTABLE POST HEADS Connectors

Surefoot Footings is the concrete free alternative to traditional concrete footings.

Surefoot is high strength, hybrid 'all-in-one' steel footings which are specifically designed to increase its efficiency when resisting gravity, uplift, shear and moment loads.

Surefoot are job specific, engineered and designed according to the soil conditions of your site.



Easy to Adjust

One person with one simple tool can easily adjust LevelMaster house stumps. Traditional house stumping and re-blocking required heavy hydraulic jacks.



Fast Results

LevelMaster adjustable stumps allow you to level a floor very accurately without the need for hydraulic jacks and packers. Making house stumping or re-blocking much faster.



Height Matters

Level Master's house stumps have a screw height adjustment of up to 120mm due to their unique design. The stump remains adjustable for the life of the building. Making it much better than traditional re-stumping or house levelling.



Durable & Strong

All LevelMaster Stump connectors, bases and tops have been hot dipped galvanised to increase durability and extend stump life.



Save on Labour

Being able to adjust the house stumps faster and with fewer steps involved allows you to cut down the amount of Labour involved.



Pre-Fabrication

LevelMaster provides a FREE assembly service to save you even more time on the jobsite (Welding not included). Just let us know the details and we will do the rest.

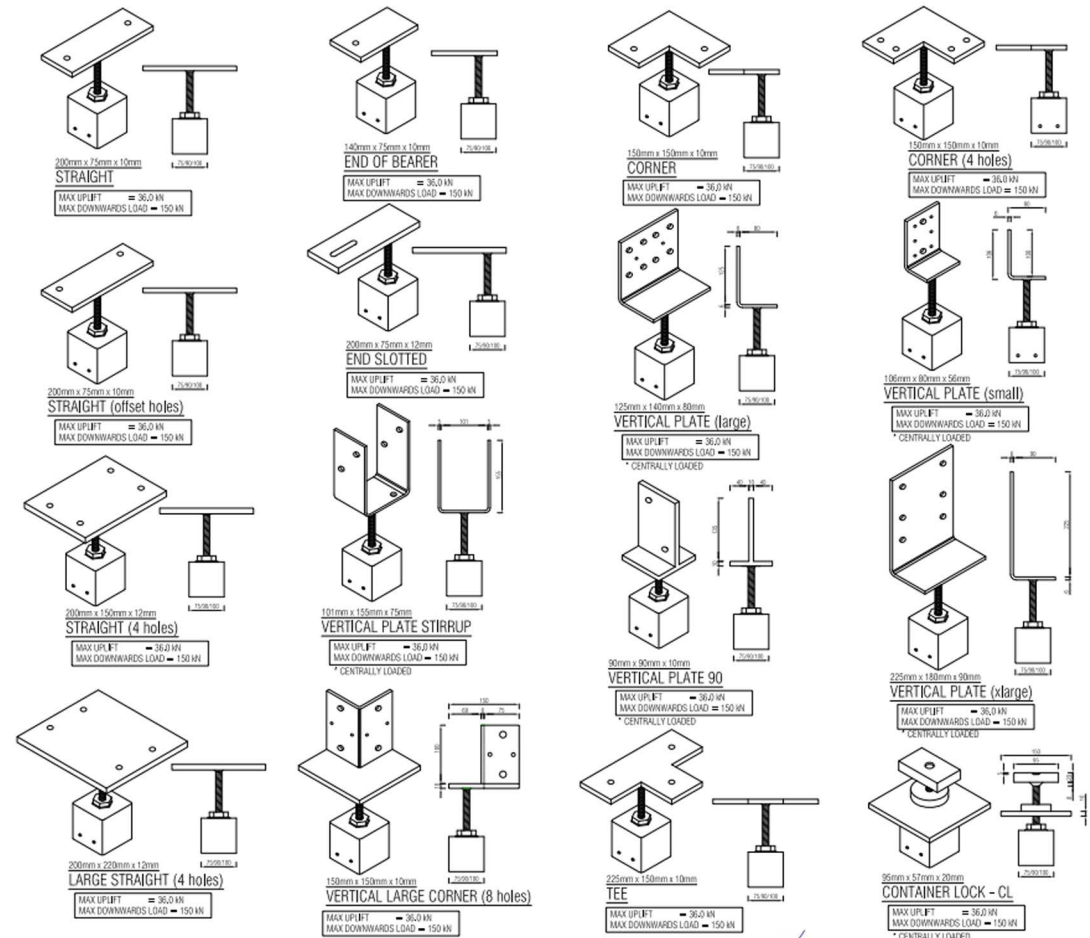

STANDARD

BUILDERS FINAL CLEAN Post Construction Offsite clean

- Removing protective tape off frames and plastic from windows
- Clean windows including window tracks & sills.
- Clearing building waste and material from inside the modular
- Sweep, scrape and vacuum all exposed floors inside the modular prior to carpet installation.
- Remove dust and debris from internal air vents
- Vacuum and clean kitchen cupboards & drawers
- Cleaning and polishing kitchen stone benchtops, sink and tapware
- Unsoiling all internal mirrored robes in bedroom
- Clean all robe shelves
- Wash bathroom shower walls, screens and floor
- Wash and polish bathtub, bathroom tiles and tapware
- Cleansing bathroom mirror, benchtop, sink and vanity cupboards
- Bathroom tile skirting (remove all grout swirls and any excess grout)
- Acid wash floor tiles (except porcelain/sensitive finishes) to completely remove grout swirls, excess grout, any paint residue, or silicone.
- Master ensuite shower wall, shower screen & shower base cleaning
- Mirror ensuite and vanity cupboards cleaning
- Clean tiled skirtings
- Neutralize floor tiles after acid washing.
- Vacuum all timber skirtings and wipe and clean any excess grout.
- Clean all electrical fixtures
- Sweep and hose decking.